

Owner's Manual

Hq9038 Tube DAC DIGITAL - ANALOG CONVERTER

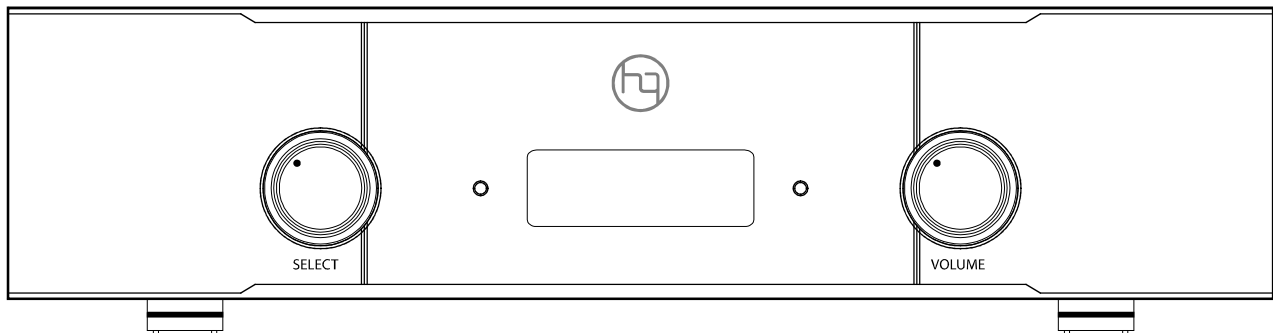
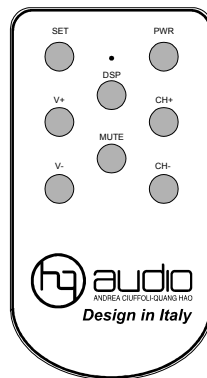

Installation and Setup.

Unpacking

The content should include:

- Hq9038 - TUBE DAC
- Remote Control
- This User Manual

Retain the packing for safe transport of your unit.

Connecting to the Mains

Check to make sure your DAC unit has been manufactured for operation at your AC line Voltage. Attempting to use the DAC at any voltage other than the specified on the rear of the unit may damage the unit. Damage caused by improper operation is not covered by warranty. If the voltage specified is different from your AC voltage, contact your dealer..

Placement

The unit is designed to run warm during normal operation but ensure you do block any ventilation openings.

Place the unit on a shelf or table. If you use an equipment Rack ensure the unit has adequate ventilation and is on its own shelf. Ensure your mains voltage corresponds to the rating plate on the rear of the unit.

Connecting Directly to a Power Amplifier

Avoid allowing static shocks to be applied to the inputs or outputs. To prevent static shocks, touch any grounded surface, such as the DACs chassis, before connecting or removing a cable. It is unlikely that a static shock will damage the unit, but it may cause circuitry to "lockup". Inputs and outputs can be safely connected to the DAC unit before it is powered up.

We strongly recommend that you use your DAC unit directly to your power amplifier. Even if you purchased your DAC unit with the intention of connecting it to your preamplifier, we suggest that you try direct connection to your amplifier. Many listeners are surprised by the improvement in performance over even the most expensive preamplifiers.

To connect your DAC unit to a power amplifier, ensure that your power amplifier is turned off then connect your analog interconnects from the DACs analog outputs to the amplifier's inputs.

Using with a Preamplifier

While the DAC unit was designed to be used without a preamplifier, no compromises were made in its design that will prevent excellent operation in a conventional system with a preamplifier.

When using a preamplifier, set the DAC units volume control to its maximum level.

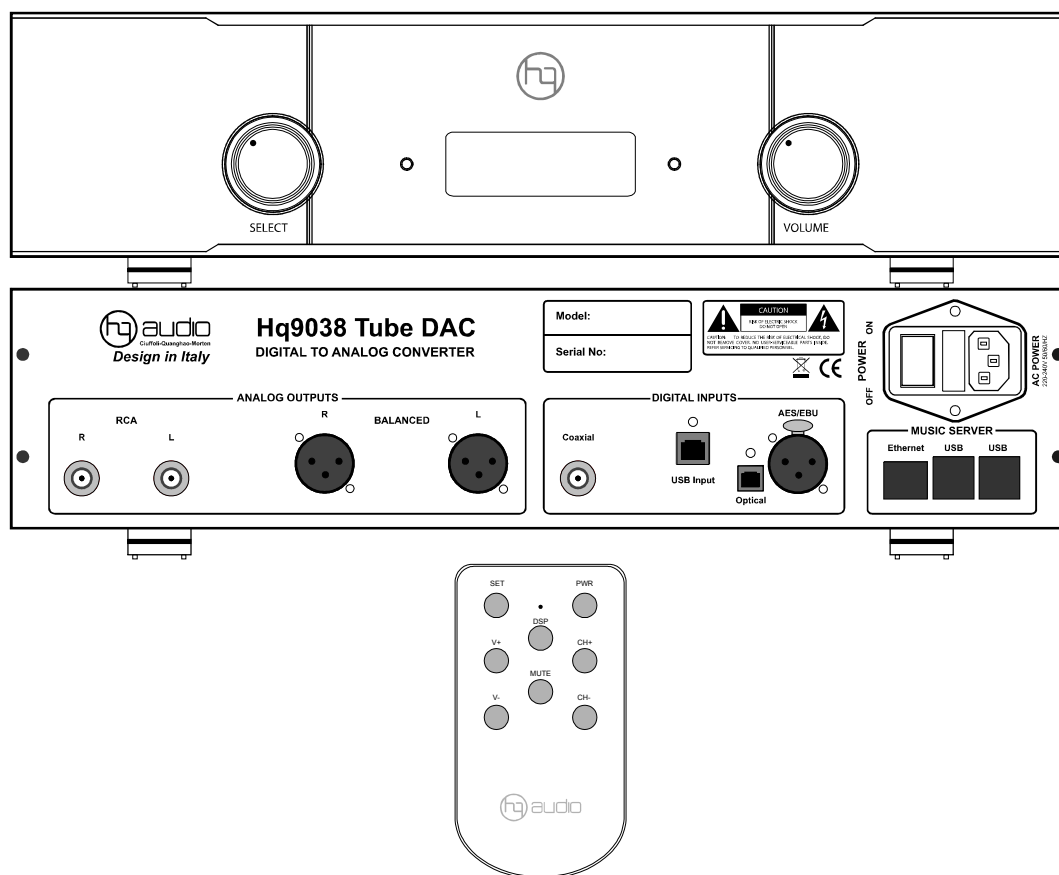

Description.

Description

The HQ Reference DAC and DSD-DAC is a Stereo High fidelity DAC unit and includes advanced specification with high performance. There are several of customizable settings within the HQ Reference DAC to optimize sound quality for a wide range of setups.

Please read this Manual before installing and operating the unit to take full advantage of all the features of this unit.

Signal input

- Coaxial S/PDIF - RCA phono coaxial
- Optical - TosLink optical
- AES/EBU - balanced
- USB 2.0 - Amanero USB

Signal output

- Tube Unbalanced stereo analog output
- Tube full balanced stereo analog output
- 32bit Digital Volume Control

Operating features

- Stand by. on/off
- Automatic detect / decode of external digital input source.
- Multiple selectable digital filter settings with preset selection.
- Analog output level and input preset selection.
- Full featured aluminium IR remote control
- Tube output to drive direct almost any amplifiers

Front panel control functions

POWER: stand by on/off
INVERT: output polarity
INPUT: select (advance)
MUTE: outputs

In frared remote controlfunctions

POWER: stand by on/off
MUTE: outputs
USB: input select
RCA: input select
XLR: Input select
OPT: Input select

Digital circuits:

The DAC unit is based on the ES9038 Sabre32 reference DAC chip from ESS Technologies. It has a patented 32-bit hyperstream DAC architecture and Time Domain Jitter eliminator. The Dac chip has build in filters for both PCM and DSD and these filters can be adjusted by the user. The Dac board is supplied from 9 low noise regulators where 7 pcs are discrete extreme low noise LT3042 regulators are used for the most critical circuits. The analog output is true unbalanced and full banlanced.

Analog circuits

Real Analogue output With Tube i/v. Balanced Output & Unbalanced Output.
The Analog circuits are designed as a input stage is a differential amplifier with 2x 12AU7 and 2X 6DJ8 output.

The HQ9038-Tube DAC has an Analogue output design that surpasses all earlier designs. The DAC chips balanced output current are converted to a voltage using the HQ unique technology. That gives a great experiences and creates unbelievably stunning soundstage. In particular, the output of the DAC has an impedance of less than 100 Ohm and 3VRMS. Wich makes it ideal for connecting the ES9038PRO to the power amplifier without the need for a pre-amplifier, giving the strongest clarity in the sound. In addition, the high-voltage supply for the Tubes in the analogue output is optimized using Mosfets with very low internal resistance and a noise level of 1 uV. The high-voltage supply are equipped with high end components and includes several non-polarized MKP capacitors that provide crystal clear sound, increased dynamic and create deep and wide sound stage.

Music server

DAC integrates a Rasberry Pi3 to be the dedicated Music Server. It Take advantage of the endless digital music sources, especially the DSD64 format are very close to the sound of the SA-CD. The time for using bundles of expensive CDs and SA-CDs is over. This Music Server will give you choose High resolution audio files. Actually, the DAC plays all formats of digital music file.

Controls and Connectors.

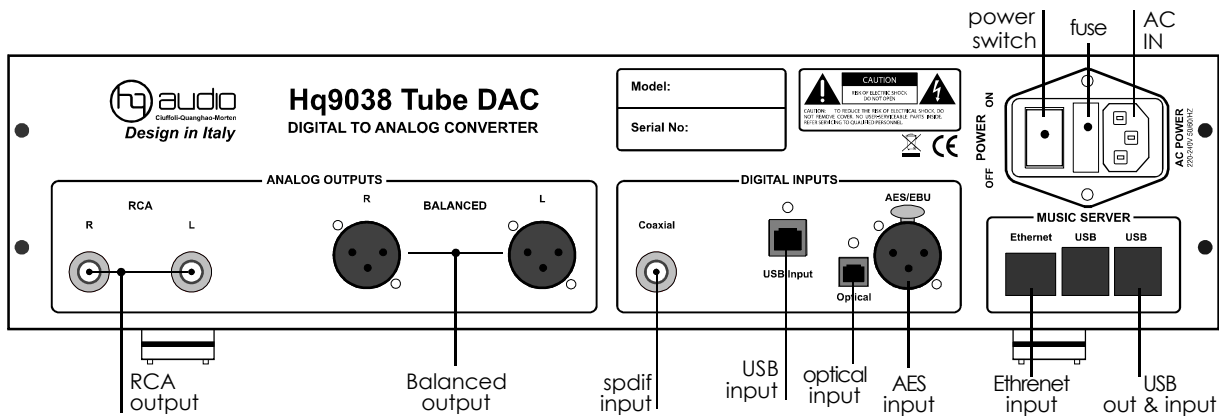
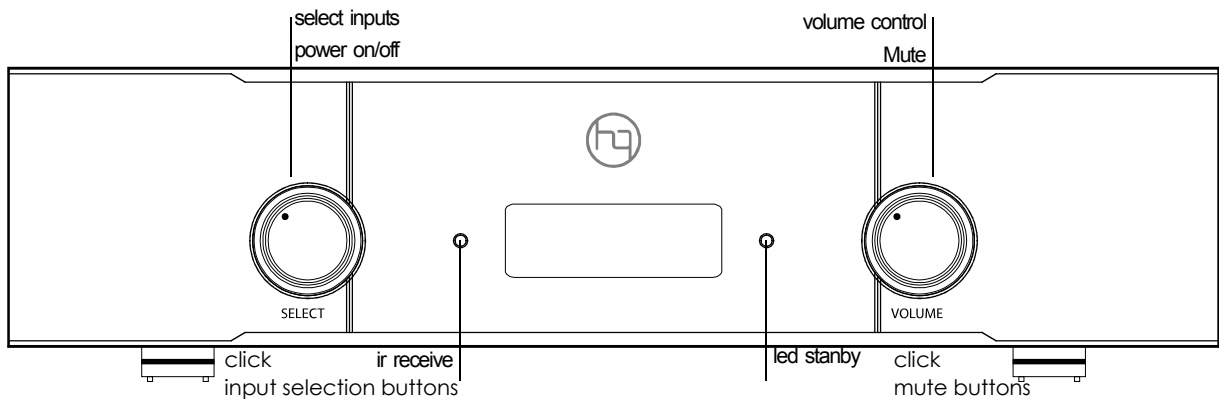

HQ9038 Tube Dac in Your Audio System

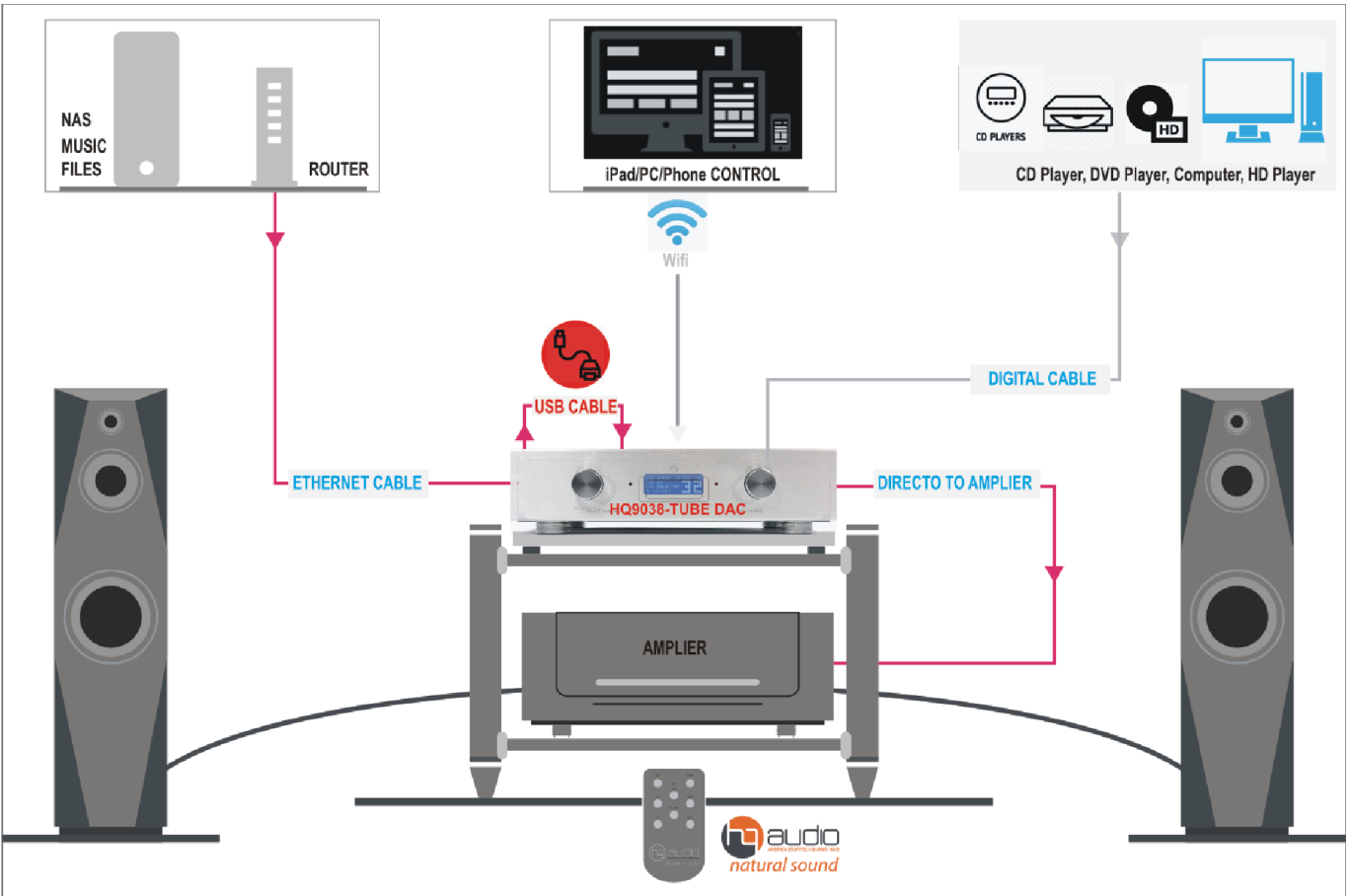

Operational.

Buttons on the front panel

Switching On and Off:

Connect power to the unit and switch the mains on. Switch on the unit.

When switching off the unit: switch off the amplifier first.

When switching on the unit: The display shows the welcome screen. After a short period the display menu shows.

Selecting input:

Push Select or Volume- buttons on the front panel to select the wanted input. When the input is selected and locked, the front panel displays input type, which can be either PCM or DSD. For PCM input the sampling frequency shows and for DSD input the sampling rate shows.

Altering the Volume Level

The volume can be adjusted by using the front panel buttons Select, Volume. The front panel displays the volume level.

Mute On/Off

Push Volume - buttons on the front panel.

Standby On /Off:

Push Select - buttons on the front panel.

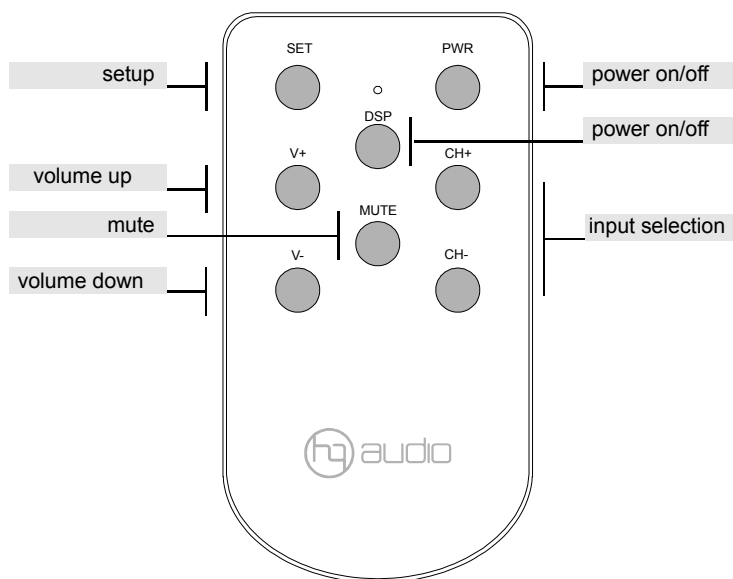

Digital filter selection:

The unit offers a wide choice of filters to enhance your listening experience. Two digital filter settings are possible, sharp roll-off and a slow roll-off for PCM mode. For DSD mode, there are 4 available filters with cut off at 47kHz, 50kHz, 60kHz and 70kHz.

For filter selection use the Remote Control.

Enter the programming mode by Pushing the SET button.

PCM filters: Select sharp roll-off or slow roll-off by pushing the buttons V+ or V-.

DSD filters: Select cut off at 47kHz, 50kHz, 60kHz or 70kHz by pushing the buttons CH+ or CH- .

Select the desired filter setting and Save the new setting by pushing the DSP button followed by the SET button.

DISPLAY Light:

Operational using the Remote Control

Custom default start up setting:

It is possible to change the default start up setting. E.g. if the optical input is often used, it can be a nice feature to have the DAC unit start up with the Optical input as default.

By pushing the **DSP** button in the "setting state" the unit will save the status for next switch-on.

Selecting input:

Push CH+ or CH- buttons on the Remote Control to select the wanted input.

When the input is selected and locked, the front panel displays input type, which can be either PCM or DSD. For PCM input the sampling frequency shows and for DSD input the sampling rate shows.

Volume Level:

The volume can be adjusted by using the Remote Control buttons V+ or V-. The front panel displays the volume level.

MUTE:

To mute the analog output, push the Mute button. Push the Mute again for unmute the analog output. The Front panel will display the Mute status.

Quick installation.

enjoy the music

1. Check carefully the input connector and AC = 220V TO 240 V mains.
2. Turn on the power switch behind the DAC.
3. Press the left button or button **SELECT / SWITCH** - on the remote control, the DAC is booted, the screen flickered to display the information.
4. Turn on and wait 60 seconds amplifier, sound is played through the DAC and you will start enjoying the music.
5. Turn off and On the DAC in standby: using the PWR button on the remote control or press button **SELECT / SWITCH** on the front panel.

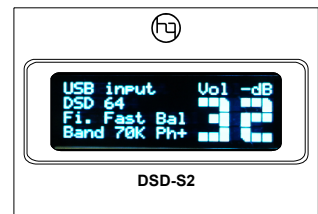
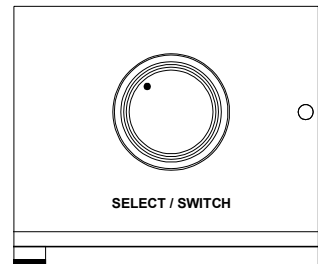
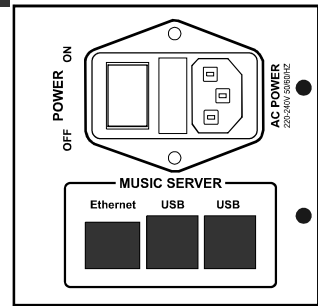

Control guide

Normal play

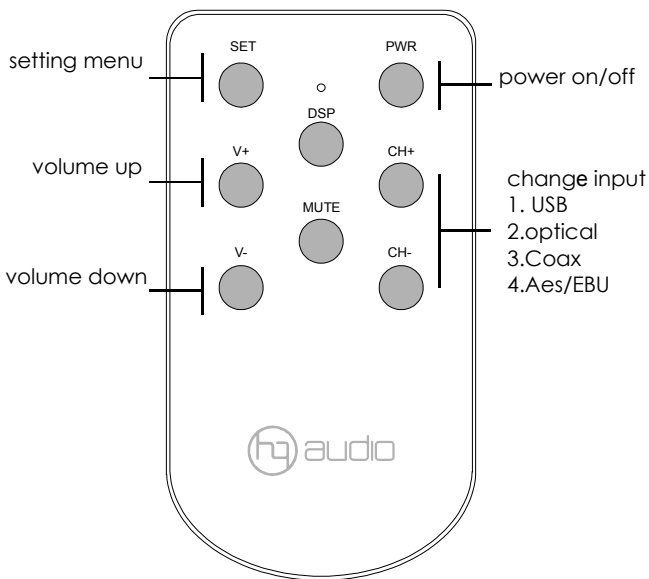

Setting menu

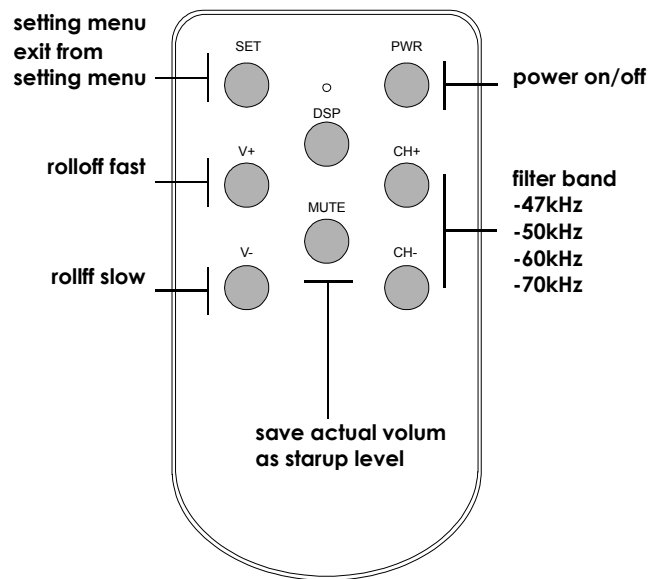

Drivers Setup.

OEM Combo384 Module

Windows ASIO Driver Installation

<http://www.amanero.com/drivers.htm>

The first step required in the Windows setup process is to install the ASIO driver:

- Don't connect the DAC unit to the PC until the driver is installed.

Don't worry if you've connected the device already. Just disconnect it.

- Download the latest driver from <http://www.amanero.com/drivers.htm>
- Don't use setup packages downloaded from other websites.
- Unzip the installation package and double-click on Install.exe to start the installation. Follow the instructions. In most cases you just need to accept the defaults on the following screens.

Mac/Linux ASIO Driver Installation

- No Drivers for these operating systems is needed.
- See limitations in specification.

Windows ASIO Driver Installation

<http://www.amanero.com/drivers.htm>

DSD-Direct Stream Digital

Direct Stream Digital, also known as DSD format - this format is not new as many people think, it is as old as digital but it wasn't used for consumer audio or home audio - before. It became very popular after 2010 and continues to make its way into our homes.

It encodes the music in the data stream differently, looks differently and sounds differently. It is the format in which the SACD discs were recorded and a format in which the analog master tapes were backed up by record companies. It is currently the format in which the master recordings are made in record industry.

Music player setup.

The Music player

To use Hq- Reference DAC and DSD-DAC with all the PCM sampling frequency and DSD sample rates, it is necessary configure the Music player (Foobar2000, Jriver or similar) to use: Windows Audio Session API (WASAPI), Kernel streaming (KS) or Audio Streaming Input Output (ASIO).

Using the default Windows driver called Direct Sound (DS) the DAC unit will work only at a specific frequency set in the Windows Audio control panel.

To work with the Kernel streaming (KS) and the Audio Streaming Input Output (ASIO) it is necessary set as predefined a different sound device on Windows Audio control panel to keep the Amanero free for the application control.

The Kernel streaming (KS) is the lower level mode to operate on Audio device so there are lower stratification in the software stack. The Windows Audio Session API (WASAPI) give less problems and it work very good with PCM and DSD tracks.

To use Foobar2000

To use Foobar2000 is much more complex

You can follows the guide on: <http://hifiduino.wordpress.com> or this following images.

download the last player SACD support (foo_input_sacd-0.6.1.zip to get foo_input_sacd.dll and ASIOProxyInstall-0.6.0.zip) ASIO4ALL (ASIO4ALL 2.11 Beta1 to get foo_dsd_asio.dll)

KernelStreaming support necessary to play 384KHz tracks (foo_out_ks.dll)

copy foo_input_sacd.dll, foo_dsd_asio.dll and foo_out_ks.dll in the directory C:\Program\foobar2000\components

If you select as output device the ASIO4ALL when you start to play any tracks an little icon will be insert in the Appl. Bar.

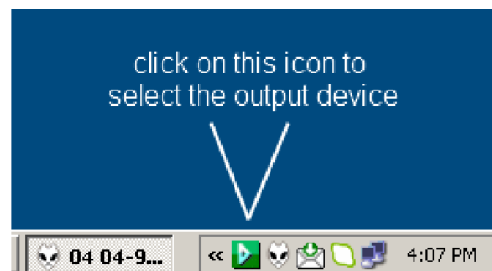
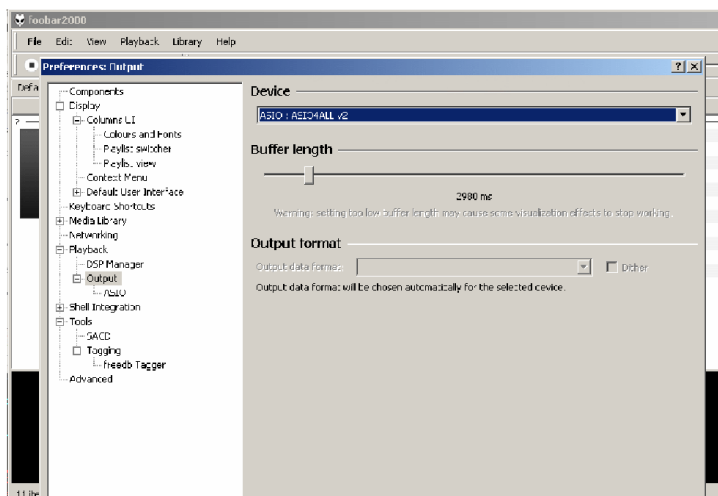

Music player setup.

JRiver DSD setting screenshots

The JRiver is more simple and with this configuration you can play 44,88,96,192,384KHz, DSD files and SACD ISO.

download the last player: <http://www.jriver.com>.

it's best to buy a license for Jriver

Direct Stream Digital, also known as DSD format - this format is not new as many people think, it is as old as digital but it wasn't used for consumer audio or home audio - before. It became very popular after 2010 and continues to make its way into our homes.

It encodes the music in the data stream differently, looks differently and sounds differently. It is the format in which the SACD discs were recorded and a format in which the analog master tapes were backed up by record companies. It is currently the format in which the master recordings are made in record industry.

1. Open Jriver and Tool/Options

2. Tool/Options/Audio

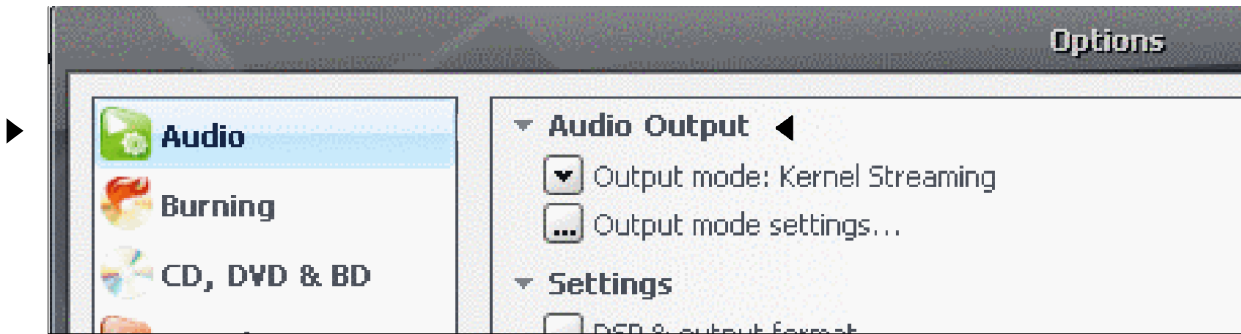

2. Audio Output /Output mode/ kernel Streaming

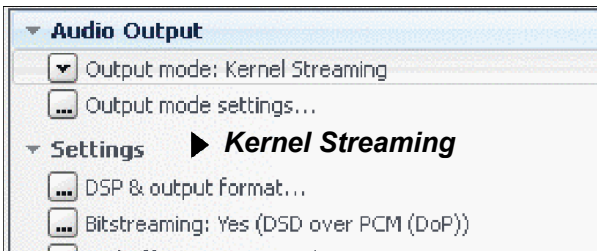

4. DSD over PCM(DoP) DoP Format: DoP 1.0 (0xFA / 0x05)

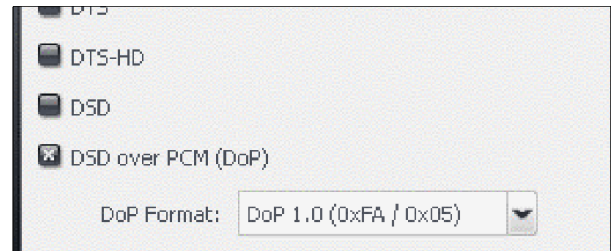

3. Audio Output /Output mode/ Bitstreaming: Yes over PCM(DoP)

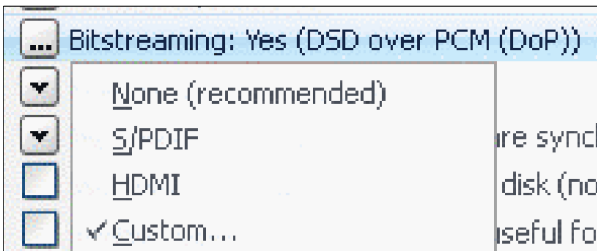

5. Ok and save Now playing

Music player setup.

Audirvana on MAC OS configuration:

The **Audirvana** is more simple and with this configuration you can play DSD files and SACD ISO.
download the last player: <https://audirvana.com/>

it's best to buy a license for Audirvana



General Optimization

- Deactivate completely iTunes own playback
Note: this option should be enabled for playing proxy files

Sound Quality optimizations at the expense of convenience functions

- Deactivate volume control by iTunes
- Deactivate play position control by iTunes

Native DSD Capability: DSD over PCM standard 1.0

Max sample rate limit: No Limit Spl rate switch: Limit max bitdepth to 24bit instead of 32bit

Optimize System for Audio Playback

Audirvana Plus priority: Very High

- Disable Spotlight
- Disable Time Machine
- Disable detection of iDevices on USB

Converter: iZotope 64-bit SRC

Quality: Fastest ————— Best

Advanced parameters

Steepness: 97 dB

Filter max length: 500,000 Samples

AudioUnits

Use AudioUnits effects

No Effect

No Effect

No Effect

No Effect

Music player setup.

Music Server in HQ-9038 Tube DAC

DAC integrates a Raspberry Pi3 to be the dedicated Music Server. It Take advantage of the endless digital music sources, especially the DSD64 format are very close to the sound of the SA-CD. The time for using bundles of expensive CDs and SA-CDs is over.

This Music Server will give you choose High resolution audio files. Actually, the DAC plays all formats of digital music file.

HQ Audio has selected the Raspberry Pi3 for music server, as this is the Music source that plays with an immersive listening experience that HQ Audio appreciate and admired for playing music better than a most then most of computers used as Music server.

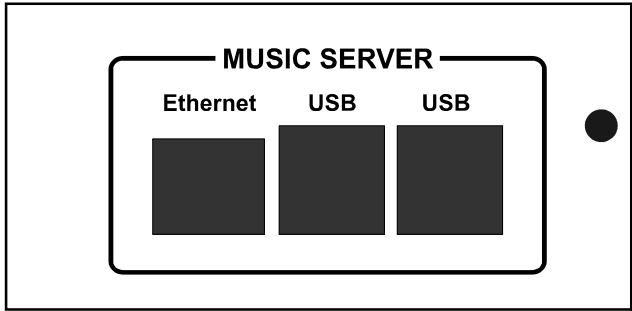

USB "A" Type

USB "B" Type

To P3 or computer

To USB DAC

Interface and music player software

The screenshot shows the 'moOde audio player' interface on a tablet. The title 'moOde audio player' is at the top left. Below it is the text 'Audiophile-quality music playback for the wonderful Raspberry Pi family of single board computers.' and a 'PURCHASE MOODE' button. The main display area shows a music player interface with a track list on the left, a central play area with a progress bar and time '00:03', and a 'Stereo Test' section on the right. A '10 Channel And Phase' section is visible at the bottom.

You can use other softwares such as:

1. <http://moodeaudio.org/>
2. <http://www.runeaudio.com/>
3. <https://volumio.org/>

The screenshot shows the 'Volumio' music player interface on a tablet. The title 'Volumio' is at the top left. The main display area features a music player interface with a track list on the left, a central play area with a progress bar and time '1:58', and a '60 /100' section on the right. The background is a dark, starry space theme.

The screenshot shows the RuneAudio website. The title 'rune audio' is at the top left. The main display area features a music player interface on a tablet, similar to the ones shown in previous images. To the right of the tablet is the text 'A REVOLUTIONARY DIGITAL HI-FI PLAYER' and 'One player to rune them all!'. Below this is the text 'RuneAudio is a free and open source software that turns embedded hardware into Hi-Fi music players.' and 'Take an inexpensive, silent and low-consumption mini-PC and make it perform as an high fidelity digital source.' At the bottom are two buttons: 'DISCOVER RUNEAUDIO' and 'DOWNLOAD'.

Music player setup.

Music Server setup with Moode Audio Player

<http://moodeaudio.org/>.

Moodaudio is software for Pi3 with many features:

1. Nice interface, easy to use.
2. Appropriate multi-DAC.
3. Connect easily, quickly, control by phone or tablet.
4. Continuous updating. Best support for users. Buy directly from Moodaudio and install it on your Pi.

Note: the "MoOde Audio" setup guide includes setup of wifi and I2S dac chip. **The DAC does ONLY support Ethernet.**

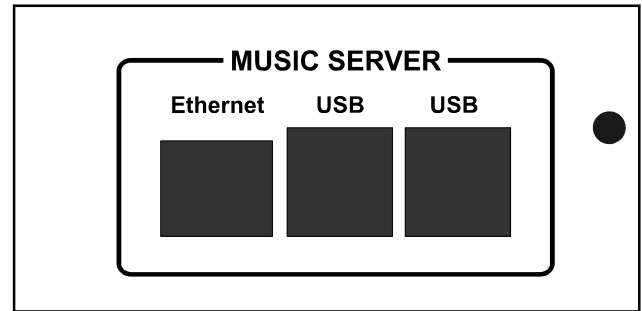
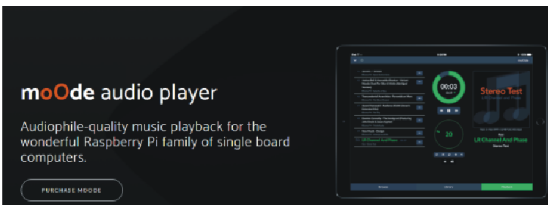

To P3 or computer

To USB DAC

SETUP GUIDE

Updated: 2017-08-23

please change to: "Please use Ver 3.8.4 or later versions of the MoOde Audio Server Soft Ware."

- Updates to moOde software are made available periodically and can be downloaded and installed from within moOde itself by clicking "CHECK for software update" on the System config screen
- Click VIEW to see a list of what is contained in the update package
- Click INSTALL to download and install the update package

WRITING MOODE IMAGE ONTO AN SD CARD OR USB DRIVE

<https://www.raspberrypi.org/documentation/installation/installing-images/>

SETUP INSTRUCTIONS

1. INITIAL SETUP

- a) insert boot SD card or USB drive
 - b) connect USB or I2S audio device
 - c) connect USB storage devices
- Ethernet mode
 - a) insert ethernet cable
 - b) power on
 - c) <http://moode>
- Access Point (AP) mode
 - a) insert WiFi adapter that supports AP mode
 - b) power on
 - c) join network SSID=Moode, pwd=moodeaudio
 - d) <http://moode.local>

2. AUDIO DEVICE SETUP

- USB DEVICE
- a) Menu, Configure, Audio, MPD options: EDIT SETTINGS
- b) leave Volume control set to "Software"
- c) set Audio output to "USB audio device" then APPLY

- I2S DEVICE

- a) Menu, Configure, Audio
- b) select an I2S audio device then SET

DSD-Direct Stream Digital

- a) reboot
- d) Menu, Configure, Audio, MPD options: EDIT SETTINGS
- e) leave Volume control set to "Software"
- f) verify Audio device is set to "I2S audio device" then APPLY

3. TIME ZONE AND AUDIO DEVICE DESCRIPTION

- a) Menu, Configure, System
- b) select appropriate timezone then SET
- c) Menu, Customize
- d) scroll down to Audio device description and select a device. The entry is for display on the Audio info screen. If a particular device is not listed then select "USB audio device". Note that I2S devices are automatically populated.

4. ADD SOURCE(S) CONTAINING MUSIC FILES

- USB AND SDCARD STORAGE DEVICES
 - a) Menu, Configure, Sources
 - b) UPDATE MPD database
 - c) WAIT for completion (no spinner on the Browse tab)
 - d) Browse tab. If more folders appear than those containing music then restart MPD
- NAS DEVICE
 - a) Menu, Configure, Sources
 - b) CREATE NAS source (MPD database update initiates automatically after SAVE)
 - c) WAIT for completion (no spinner on the Browse tab)
 - d) Browse tab. If more folders appear than those containing music, restart MPD

5. VERIFY AUDIO PLAYBACK

- Ethernet mode
 - a) <http://moode>
 - b) Play one of the radio stations
- AP mode
 - a) <http://moode.local>
 - b) Browse, SDCARD, Stereo Test
- a) [...] Menu for "LR Channel And Phase" track
 - d) Play

At this point a FULLY OPERATIONAL PLAYER exists.

=====

Music player setup.

Music Server setup with Moode Audio Player

CUSTOM CONFIGS
 Customize the player by using any of the following procedures.

=====

1. CONFIGURE FOR WIFI CONNECTION

- Ethernet mode
- a) leave eth cable connected
- b) insert wifi adapter (while Pi running)
- c) http://moode
- d) Menu, Configure, Network
- e) configure a wifi connection
- f) Menu, Restart, Shutdown
- g) unplug eth cable
- h) power on
- Access Point (AP) mode
- a) join network SSID=Moode, pwd=moodeaudio
- b) http://moode.local
- c) Menu, Configure, Network
- d) configure a wifi connection
- e) Menu, Restart, Reboot

2. CHANGE HOST AND SERVICE NAMES

- a) Menu, Configure, System (and Audio)
- b) SET after entering appropriate value in each name field
- c) reboot is required if changing Host name and/or Browser title

3. AUTO-CONFIGURE AT BOOT

NOTE-1: this works only on a fresh image that has never been booted!

NOTE-2: to start AP mode at boot set wlanssid to blank e.g., wlanssid=

- a) change values in the file below
- b) paste contents into /boot/moodecfg.txt
- c) sudo reboot
- d) join SSID if AP mode
- e) http://hostname.local

```
#####
# Copy this file to /boot/moodecfg.txt
# worker will process it at startup then
# delete it and automatically reboot.
#####
```

```
[names]
hostname=moode
browsertitle=moOde Player
airplayname=Moode Airplay
upnpname=Moode UPNP
dlnaname=Moode DLNA
mpdzerconf=Moode MPD
```

```
[services]
airplaysvc=0
upnpsvc=0
dlnasvc=0
```

```
[network]
wlanssid=MySSID
wlansec=wpa
wlanpwd=MyPassword
apdssid=Moode
apdchan=6
apdpwd=moodeaudio
```

```
[other]
timezone=America/Detroit
themecolor=Emerald
```

=====

AFTER PLAYER SETUP

Follow these instructions for making certain types of changes

=====

1. Switching from USB to I2S audio device

- a) unplug USB audio device
- b) Menu, Restart, Shutdown
- c) install I2S audio device
- d) power on
- e) Menu, Configure, Audio
- f) select appropriate I2S audio device then SET
- g) Menu, Restart, Reboot
- h) Menu, Configure, Audio, MPD options: EDIT

SETTINGS

- i) Verify Audio output set to "I2S audio device"
 - j) APPLY
- ### 2. Switching from I2S to USB audio device
- a) Menu, Configure, Audio
 - b) select "None" for I2S audio device then SET
 - c) Menu, Restart, Shutdown
 - d) optionally unplug I2S audio device
 - e) plug in USB audio device
 - f) power on
 - g) Menu, Configure, Audio, MPD options: EDIT
- ### SETTINGS
- h) Select "USB audio device" for Audio output
 - i) APPLY

3. Switching from WiFi back to Ethernet

- a) plug in Ethernet cable
- b) Menu, Configure, Network
- c) RESET network configuration to defaults
- d) Menu, Restart, Shutdown
- e) Remove WiFi adapter
- f) power on

===== END SETUP GUIDE

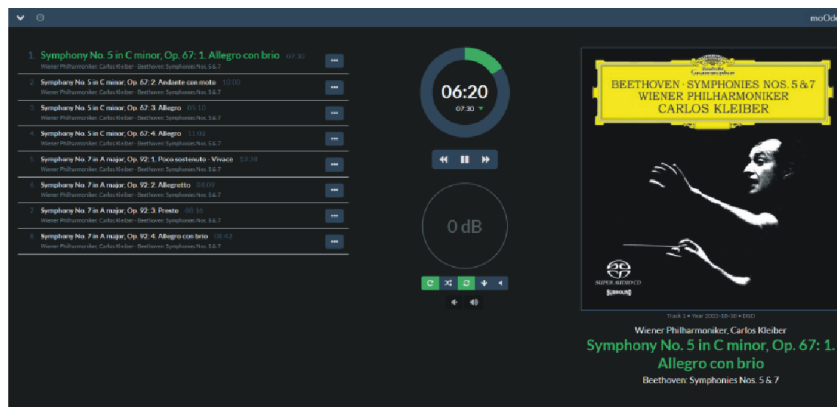

Frequency Asked Questions.

Balanced or Unbalanced connection?

If your amplifier has a true balanced input, we recommend to use the balanced analog output from your New DAC. All things being equal, properly implemented balanced (also called differential) circuitry sounds better than unbalanced circuitry. The DAC unit is a true balanced design. It generates the inverted signal in the digital domain and all subsequent processing is done in balanced mode. The DAC is designed to maintain many of the advantages of true balanced design when using the unbalanced outputs. In addition, the DAC analog output stage is capable of driving both types of outputs simultaneously.

Bypass the Preampifier?

A preamplifier is unnecessary when using your DAC unit. The DAC Unit provides all the necessary control functions of a preamp while the signal is still in the digital domain. This avoids the sonic degradation caused by analog circuitry, switches, and wire. The DAC units Analog output stage can drive any power amplifier and any interconnects, even at very long lengths.

Leave the DAC unit with the power on?

The DAC unit is designed to be left with the power on with no harm or wear to the unit. If desired, the front display can be turned off (see Turning off the Display under Remote Operation). Leaving the power on allows the circuitry to remain in thermally stable, which provides better performance and longer life.

Careful listeners will notice that the sound of the DAC unit will improve steadily after the unit is powered up. A new unit will undergo more dramatic changes when power is applied for the first time. If you turn off your DAC unit for more than an hour, you will find that the unit will undergo similar, but less dramatic improvement once power is reapplied.

Bypassing the Volume Control?

Because the Digital Volume control does not include any analog circuitry, there is none to be bypassed. Even the mathematical program step that performs the Digital Volume Control calculation is an integral part of the HQ Reference DAC filter algorithm and therefore cannot be bypassed. If you do not need the Volume Control, set it to its maximum level of -0dB on the display, and save this level for the next switch-on using the remote command (SET + DSP).

Does the Volume Control compromise resolution?

The unit uses the latest generation proprietary digital volume control.

The volume level can be varied in the digital domain by means of mathematical manipulation of the signal, eliminating the distortion and noise that are inevitable with even the best analog volume controls. While conventional thinking indicates that reducing the volume digitally can sacrifice low level resolution, the DAC unit uses an innovative digital filtering algorithm produces a 32 bit output rather than the 16 bits stored on the CD. This high-resolution signal is then used in the computations which in turn reduce the volume level. This new signal is fed directly to the DAC inside the chip. Through this innovative method, the DAC unit maintains high resolution even at the lowest volume control settings.

Replacement Tube Set RTPR9 - software for Pi3

Replacement Tube Set RTPR9

V2 & V4: 12AU7
V1 & V3: 6DJ8

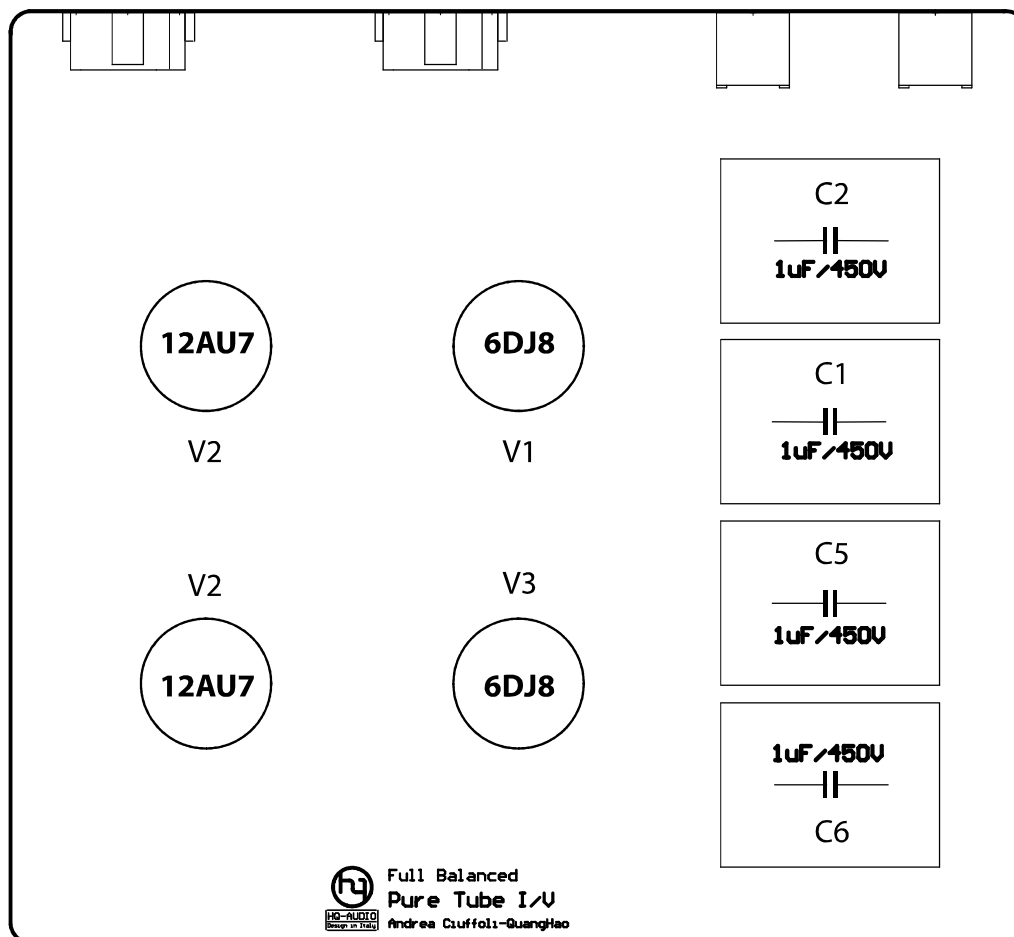

Please visit the following pages to see how to record your memory card for the Pi3

1. <http://moodeaudio.org/>
2. <http://www.runeaudio.com/documentation/>
3. <https://volumio.org/>

Thanks you very much!

Specifications.

Specifications

Main DAC:	ESS Sabre32 Reference ES9038PRO DAC chip Support 44,88,96,192,352,384kHz PCM and DSD to play SACD ISO. Full ground isolation from USB module. On board reference 100MHz Crystek oscillator with a jitter of 0.5psecUltra fast oscillator buffer. Digital supply & Analog supply - LT3042-Ultralow Noise
Resolution:	32bits
Audio Outputs:	2 x RCA phono, 2 x Balanced XLR
Output impedance: (analog)	under 100 ohms
Output Levels:	3.0V RMS fixed, 6.0V RMS Balanced.
Frequency Response:	10Hz to 20kHz +0.1dB
Total Harmonic Distortion:	<0.015%
Digital Inputs:	1 x Amanero USB 1 x Coaxial S/PDIF - RCA phono 1 x Optical - TosLink optical 1 x AES/EBU - Balanced
Input Format Support:	
Spdif, Optical, AES/EBU:	PCM 16-24Bit /44.1kHz, 48kHz, 88.2kHz, 96kHz, 176.4kHz, 192kHz.
USB:	PCM 16-32Bit /44.1kHz, 48kHz, 88.2kHz, 96kHz, 176.4kHz, 192kHz, 352.8kHz, 384kHz 705.6kHz, 768kHz DSD DSD64/128/256 (DoP/dCS) DSD64/128/256/512 (ASIO Native) PCM 16-32Bit /44.1kHz, 48kHz, 88.2kHz, 96kHz, 176.4kHz, 192kHz, 352.8kHz, 384kHz, 705.6kHz, 768kHz DSD DSD64/128/256 (DoP/dCS) DSD64/128/256/512 (ASIO Native).
Music Server:	Interface and music player software Moodaudio - Runeaudio - Volumio
Wifi:	802.11 b/g/n Wireless LAN.
Ethernet:	802.11 b/g/n Wireless LAN.
USB:	4 x USB 2.0 ports
Remote Control:	Turn on / Set / Volume / Mute / Select signal channel
Mains Power:	220V-240V, 50/60Hz
Power Consumption:	<100W
Dimensions (H x W x D):	100 x 350 x 435mm
Weight:	12.5kg
Finish:	Silver
Note:	<i>Specifications may be subject to revision.</i>

The design team behind the Hq9038-Tube DAC works on separate technical aspects of the project and are dedicated electronics engineers with more than 50 years experience as audiophiles. This ensures an open mind to audible phenomena.

The design team bring to their labors skill, pride and with an unbridled enthusiasm which takes the engineering and critical evaluation of Audio equipment to new levels, reflected in the exacting standards to which every product is designed and manufactured.

To ensure the highest standard of each Hq9038, it will before leaving the factory be verified and final tested to ensure the final voicing. This verification is ensured personally by Hq-Audiodesign.



HQ-Audio

11th floor room 1116

Kimvan-Kimlu

Hanoi-Vietnam

Tel: +84 902578899

W: www.quanghao.com

W: www.audiodesignguide.com

E-mail: quanghao168@yahoo.com.vn